

**Distributed I/O Module 16 PNP outputs communicating over RS-485**

**DAT 3116**

**FEATURES**

- Modbus Server device on RS-485
- Modbus RTU/ Modbus ASCII protocol
- 16 digital outputs type PNP transistor
- Watch-Dog Alarm
- Short-Circuit Alarm
- Remotely Configurable
- 1500 Vac 3-ways Galvanic Isolation
- LEDs of signalling on front side for power supply and communication
- LEDs of signalling on front side for digital inputs and outputs state
- Connection by removable screw terminals
- CE / UKCA mark
- DIN rail mounting in compliance with EN-50022

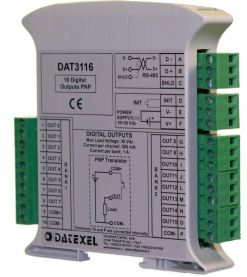

**GENERAL DESCRIPTION**

The device DAT3116 is able to drive up to 16 digital outputs type PNP transistor. The data are transmitted with MODBUS RTU / MODBUS ASCII protocol over the RS-485 network. To ensure the plant safety, a Watch-Dog timer alarm is provided. The isolation between the parts of circuit removes eventual ground-loop effects, allowing the use of the device even in the heavy environmental conditions. The device is housed in a rough self-extinguishing plastic container which allows a high density mounting on EN-50022 standard DIN rail.

**USER INSTRUCTIONS**

Before to install the device, please read the "Installation Instruction" section. It is possible to configure the device via software using the INIT modality. Connect the terminal INIT to the terminal -V; at the power-on the device will be automatically set in the configuration set-up (refer to the User Guide of the device). Connect power supply, serial bus and digital outputs as shown in the "Wiring" section. The LEDs state depends on the working condition of the device: see the "Light Signalling" section to verify the device working state. To perform configuration and calibration operations, read the instructions in the User Guide of the device. To simplify handling or replacing of the device, it is possible to remove the wired terminals even with the device powered.

**TECHNICAL SPECIFICATIONS (Typical @ 25 °C and in the nominal conditions)**

DIGITAL OUTPUTS		SERIAL OUTPUT	GENERAL SPECIFICATIONS
<b>Number of Channels</b>	16	<b>Data Transmission (asynchronous serial RS-485)</b> Baud Rate 115.2 Kbps Max. distance 1.2 Km – 4000 ft	Power supply voltage 18 .. 30 Vdc Reverse polarity protection 60 Vdc max <b>Max. Current consumption</b> 70 mA
<b>Type</b>	PNP		<b>ISOLATION</b> Between all ways 1500 Vac, 50 Hz, 1 min
<b>Voltage</b>	10.5÷30 Vdc		
<b>Maximum load(*)</b> Outputs 0÷7 (Group 1) Outputs 8÷15 (Group 2)	500 mA per channel max 1 A max 1 A		<b>ENVIRONMENTAL CONDITIONS</b> Operative temperature -20°C .. +60°C Storage temperature -40°C .. +85°C Humidity (not condensing) 0 .. 90 % Maximum Altitude 2000 m slm Installation Indoor Category of Installation II Pollution Degree 2
<b>Inductive Load</b>	48 Ω – 2H max		
(*) Protection against over-current and temperature Short-circuit current 1.7 A for each outputs bank Group 1: outputs from 0 to 7 Group 2: outputs from 8 to 15		<b>MECHANICAL SPECIFICATIONS</b> Material Self-extinguish plastic IP Code IP20 Wiring wires with diameter 0.8÷2.1 mm <sup>2</sup> AWG 14-18 Tightening Torque 0.5 N m Mounting in compliance with DIN rail standard EN-50022 Weight about 170 g.	

## INSTALLATION INSTRUCTIONS

The device is suitable to be mounted on DIN rail, in vertical position. For an optimum operation and long life follow these instructions. When the devices are installed side by side it may be necessary to separate them by at least 5 mm. If panel temperature exceeds 45°C and power supply voltage 18 Vdc. Make sure that sufficient air flow is provided for the device avoiding to place raceways or other objects which could obstruct the ventilation slits. Moreover it is suggested to avoid that devices are mounted above appliances generating heat; their ideal place should be in the lower part of the panel. Install the device in a place without vibrations. Moreover it is suggested to avoid routing conductors near power signal cables (motors, induction ovens, inverters etc...) and to use shielded cable for connecting signals.

## CABLING

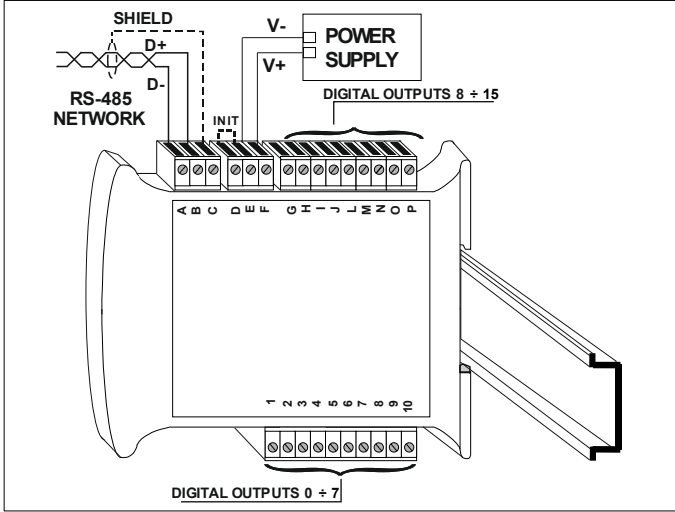

## LIGHT SIGNALLING

LED	COLOR	STATE	DESCRIPTION
PWR	GREEN	ON	Device powered
		OFF	Device not powered
		BLINK	~1 sec. - Watch-Dog alarm condition occurred
STS	YELLOW	BLINK	~1 sec. - INIT condition
		ON	Short-Circuit alarm condition occurred
Rx	RED	BLINK	Stream of data over receiving line of RS-485
		OFF	No data over receiving line of RS-485
Tx	RED	BLINK	Stream of data over transmission line of RS-485
		OFF	No data over transmission line of RS-485
DO <sub>n</sub>	RED	ON	Digital output ON state
		OFF	Digital output OFF state

## ISOLATION STRUCTURE

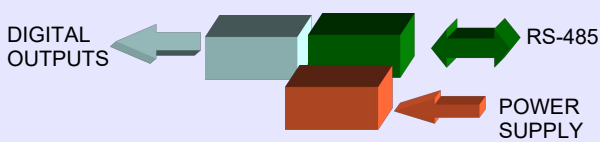

## MECHANICAL DIMENSIONS (mm)

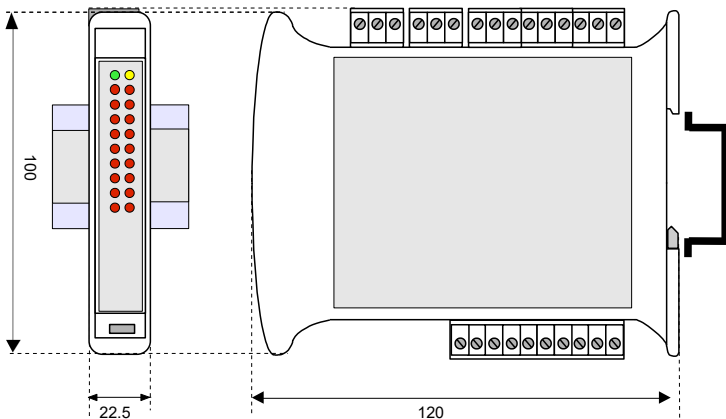

The symbol reported on the product indicates that the product itself must not be considered as a domestic waste. It must be brought to the authorized recycle plant for the recycling of electrical and electronic waste. For more information contact the proper office in the user's city, the service for the waste treatment or the supplier from which the product has been purchased.

## WIRING

### POWER SUPPLY (\*)

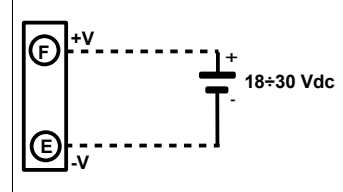

### INIT

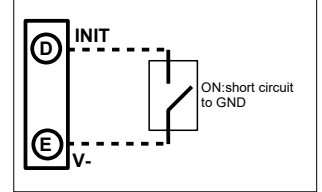

(\*) Note: the device must be powered using a power supply unit classified NEC class 2 or SELV with limited energy

### DIGITAL OUTPUTS

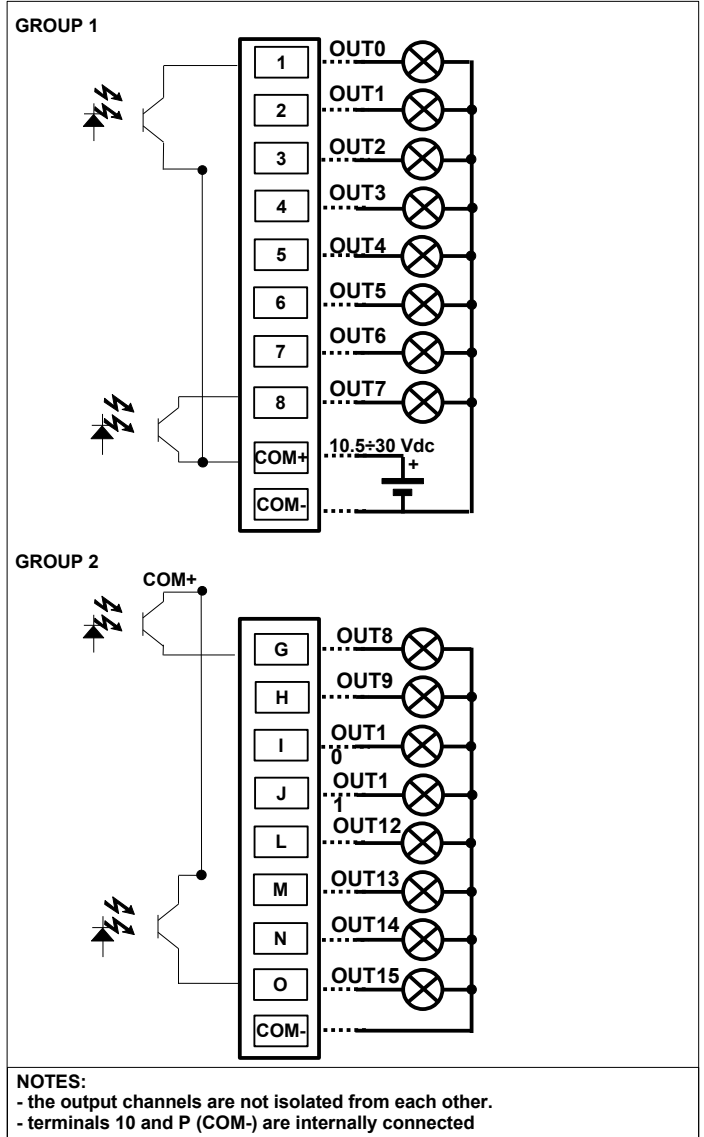

### RS-485

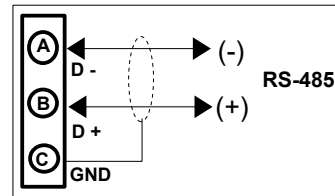

## HOW TO ORDER

**ORDER CODE:**  
DAT 3116